

This Scooter Costs Only \$75



If you can fix a bike, you can build a put-put that's almost as convenient as a second car and costs far less to run.

By Howard G. McEntee

YOU simply get on this homemade scooter and go. There's no clutch, no gearshift. Open the throttle and you're off. Tackling a grade? It shifts down automatically. When the going is easy, it shifts up again.

Hard to build? No. Though it looks like



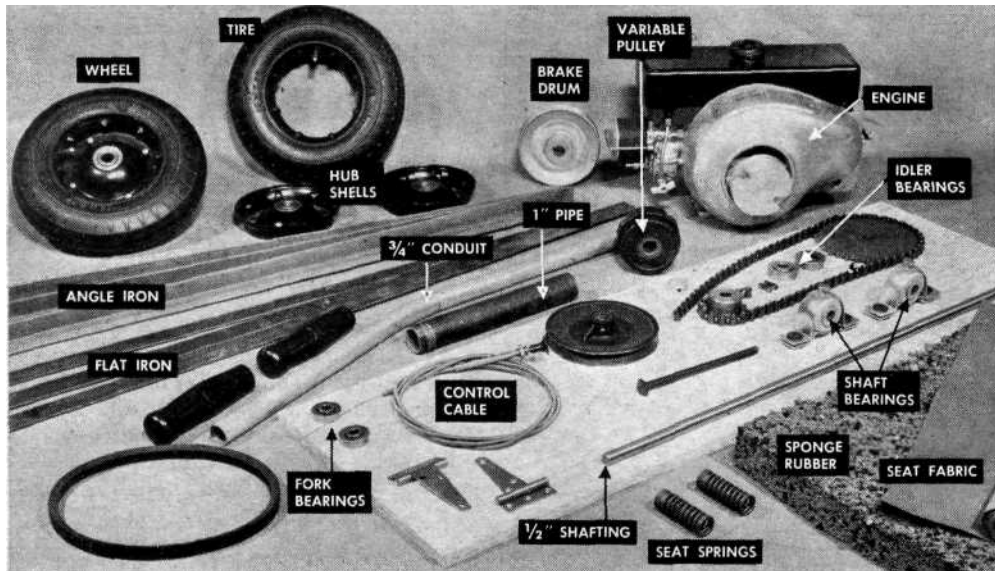

These are the main parts, but you'll need such extras as bolts and nuts, 1/2" and 3/8" pipe, lock

washers, sheet metal for fenders, wheel dust seals, and brake and idler springs.

something off a sweet-running assembly line, it isn't a tough job. If you can take a bike apart and get it together again, you can handle this, too.

Scooters are taking thousands to work, school, play, and the corner drugstore for just pennies a day. And no wonder. These little puddle jumpers are a cinch to handle. They park on a grease spot, and can be licensed at bargain rates. This one's a bargain in other ways, too.

What's it got? A lot, in view of today's high prices. Here's what your \$75 buys: An easy-starting, lightweight two-cycle engine, an automatic clutch with variable drive ratio, an efficient brake, pneumatic tires, chain drive, lights, and a spring-mounted foam-rubber seat.

The engine is the most expensive item, but fortunately there are reliable two-cycle engines available for \$25 or less.* If you have a suitable engine or can rebuild a used one (see PS, June '51 p. 187), this figure can drop to the vanishing point.

What'll it do? You won't beat even a Model A from the light in this little job. But the take-off is smooth, and you'll get where you're going at something like 20 miles an hour. Although it would bust before making Pikes Peak, it will take you up easy grades and can be walked up stiff ones

under its own power. The brake is effective, starting is a cinch, and roadability is good. The machine is light enough to carry if necessary, and one man can put it into an auto luggage compartment.

Welding does it. The cost includes \$6 for welding the frame, and it's money well spent. Although you could bolt or rivet the frame together, you'd have to overlap members or provide gussets at all joints. But welding service is available everywhere, and a welded frame is much easier to make, neater looking, and stronger.

You'll find most welders cooperative, especially if you cut and fit frame members correctly and clamp them in proper alignment. Electric welding is preferable. It's less likely to warp the stock.

Cutting the frame. Two 45" lengths of angle iron must be cut, bent, and welded at two points. For the 30° upward bend, cut through one flange of each piece 12 1/2" from an end. Watch yourself, for these members are not identical; you need a right and a left. Bend the uncut flange, spreading open the cut. Then have 1/8" reinforcing plates welded across the breaks.

The second bends are in the other flanges, and require narrow notches. These are closed up by bending, and need no reinforcing, just careful welding. The front of the frame is filed to fit around the head. Try to make the two parts a reasonably close

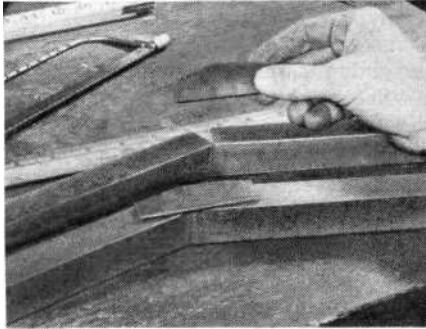

Measuring 12 1/2" from ends of main frame members, cut through one flange, and bend the other up about 30°. Be sure to make one right, one left. Cut 1/8"-thick braces to be welded across the breaks. Weld across them inside the angle also.

First bend (at right) has been welded in both members and a 3/8"-wide V notch cut 2" above it. Second bend closes these notches, ready for welding. Clamps hold a crosspiece in place. Head (in hand) will be welded to rounded frame ends.

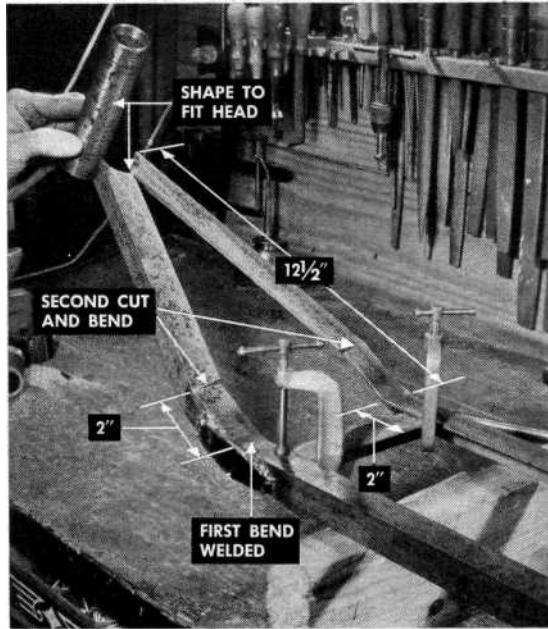

match, but don't fret about it, for welding will close up small gaps.

Assembling the frame. The fork turns in ball bearings like those in the wheels, but made for a 3/8" axle. The 1" pipe for the head can be bored out in a lathe to fit the bearings, or filed by hand, since the outer race does not turn. Cut the angle brace. Then wire it and the head in place for welding, or drill the frame members for a clamping bolt and have the holes welded. **Diagonal frame brace** is welded between the head

up later. Make sure the head is vertical to the frame, as viewed from the front, or your wheel will be askew.

Note that, except for the axle slots, no holes are made in the vertical flanges of the long frame members. All other holes go in the top flanges, which don't carry much of the load.

The scooter shown was assembled mostly with square-shoulder carriage bolts, for which you must file the hole square. This

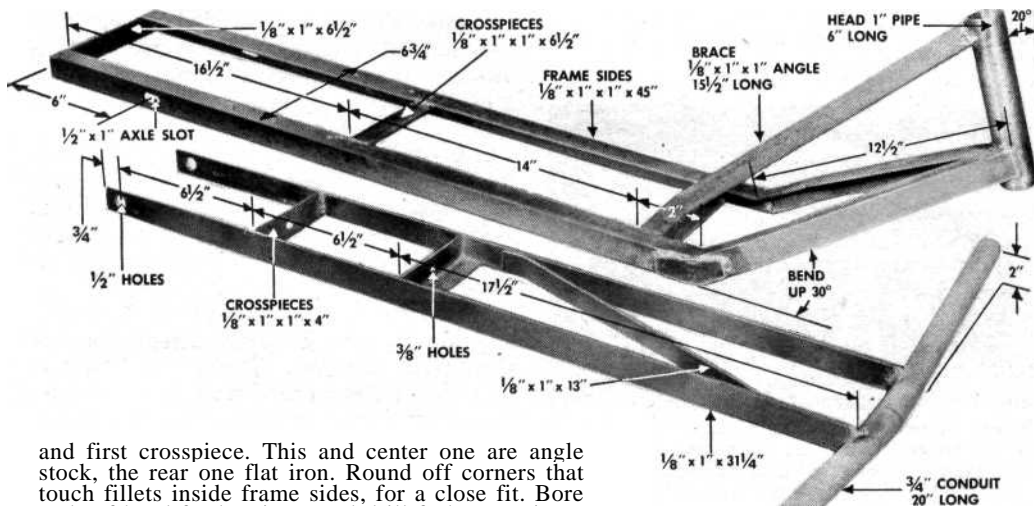

and first crosspiece. This and center one are angle stock, the rear one flat iron. Round off corners that touch fillets inside frame sides, for a close fit. Bore ends of head for bearings, and drill fork crosspieces for kingbolt, before welding.

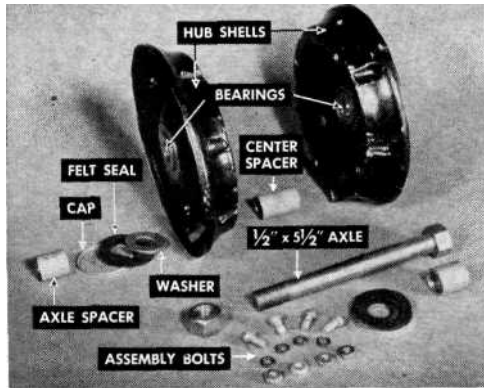

Makings of a wheel hub. Ball bearings are in place in the shells. Center spacer must clamp between inner races without binding the bearings. A lathe is ideal for facing spacers squarely to length. Felt seals prolong bearing life. Bolts and nuts clamp hub together.

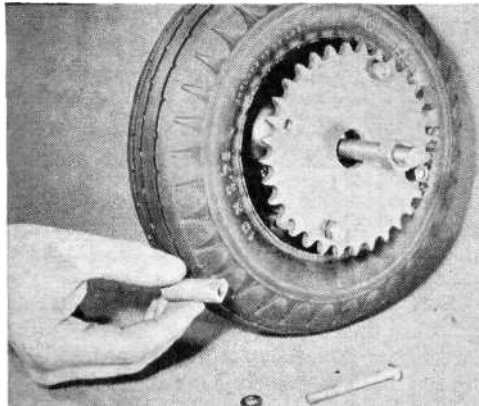

Industrial type sprocket used here was bored out to clear the axle spacer. Sprocket is set off by four spacers $1\frac{9}{16}$ " long, cut from $\frac{3}{8}$ " pipe. Spacer ends against sprocket are square, but inner ends are filed to contour of hub shells. The holes in the shells must be opened out to clear $\frac{1}{4}$ "-20 bolts.

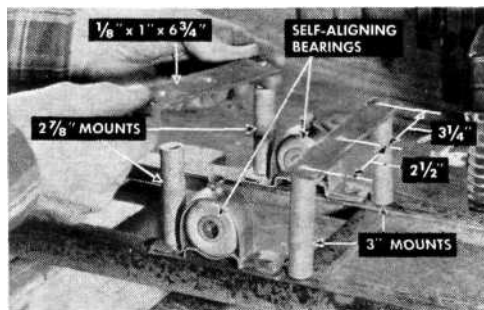

Front engine mounts rest directly over the center frame crosspiece. The rear ones sit on the bearing hangers, and therefore are $\frac{1}{8}$ " shorter. All mounts are cut from $\frac{1}{2}$ " pipe. Iron straps across them provide an inboard support for the engine base, in which the mounting holes are $3\frac{1}{4}$ " apart.

takes only a few seconds and saves time in assembly, because it isn't necessary to fumble underneath with wrenches to hold a bolt while cinching up the nut.

Lock washers under all nuts are, of course, a must if you want the scooter to be roadworthy. Don't under any circumstances omit them.

Wheels. These are 10" by 2.75" tubeless pneumatics, inflatable through a valve. Valveless (semi-pneumatic or zero pressure) tires give a harder ride. Be sure to get the heavy-duty grade, since light-service tires of both types aren't recommended for much more than wheelbarrow speeds. ,

At least the rear wheel must be the lug-base type, having molded protuberances on the tire that fit indentations in the hub. Make certain you have this kind, or you may find the hub going around while tire, scooter, and rider stay put.

To prevent the bearings from turning directly on the axle, the inner races must be clamped against a center spacer. This and outside spacers can be cut from ordinary $\frac{1}{2}$ " pipe drilled out a bit. Each center spacer must be carefully fitted. If too long, it won't allow the hub to be assembled; if too short, it will bind the bearings. Each wheel must turn freely when clamped with axle nuts with the center spacer in. Start with this spacer a trifle long, and shorten it a little at a time.

The front axle is simply a $\frac{1}{2}$ " hex bolt $5\frac{1}{2}$ " long. If you can't get one 8" long for the rear axle, use a square-head machine bolt or a $\frac{1}{2}$ " shaft threaded at both ends.

Chain drive. The roller chain shown is No. 41, $\frac{1}{2}$ " pitch and $\frac{1}{4}$ " wide. This is stronger than necessary. Similar chain $\frac{1}{8}$ " wide is stocked by bicycle stores and will serve as well.

The sprockets should give a ratio of about $2\frac{1}{2}$ to 1. The large (32-tooth) sprocket is fastened to the rear hub with $\frac{1}{4}$ "-20 bolts on spacers cut from $\frac{3}{8}$ " pipe. Mount the wheel and spin it to help you true up the sprocket.

Countershaft. Bearings are the self-aligning type, which make assembly easier than rigid bearings. The $\frac{1}{2}$ " countershaft must be at 90° to the frame, with the rear axle parallel to it, for quiet chain operation. The small sprocket (13-tooth) must be pinned to the shaft. Setscrews will not hold. Drill a hole through hub and shaft, ream with a No. 3 taper reamer, and drive in a taper pin.

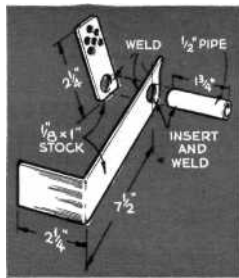
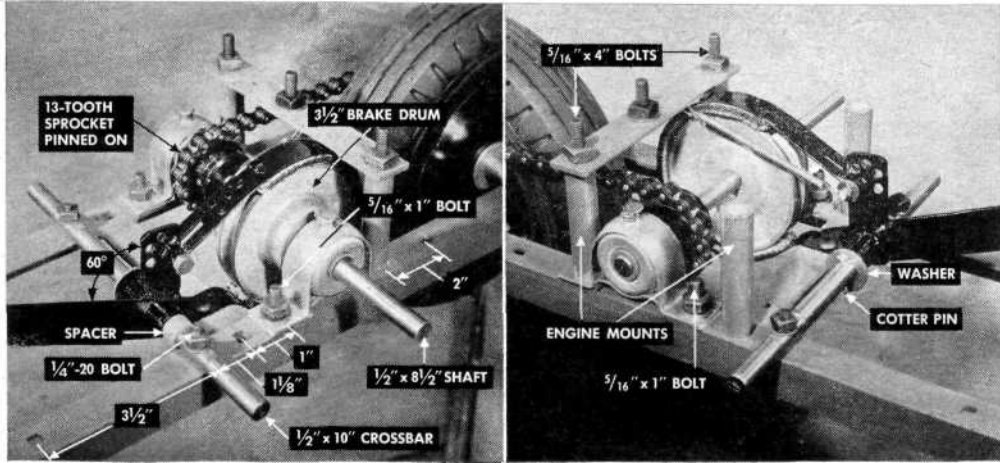

A crossbar of 1/2" shafting is filed flat where it crosses the frame, and bolted on. Brake lever is welded of 1/2" pipe and 1" strap as at left. It pivots on the crossbar. So does the idler bracket on the drive side and the kick stand on the other. Pointed end of brake lever strikes frame crosspiece as a stop. Brake band is looped over, riveted, and notched to form clevis as at right. Clevis pin is unthreaded portion of a bolt. Lower end of brake band is bolted to frame crosspiece. Engine will rest directly on straps, not on nuts shown.

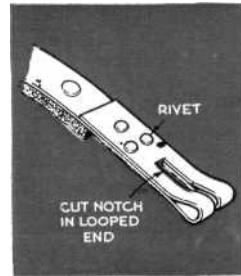

A shaft collar goes between this sprocket and the nearer bearing. The brake drum takes the side thrust at the other bearing. Leave just a little end play.

Brake. Use a 3 1/2" steel or cast-iron flat pulley for the drum if possible—a die-cast one will wear rapidly. The scooter shown has an iron V pulley with the sharp ridge turned off the flanges. Pin the drum fast, or use two setscrews tightened against flat spots on the shaft.

The brake band is a flexible strip of 1/16" by 3/4" steel. Bend the band around the drum before riveting on some 1/8"-thick woven brake lining. Bolt the lower end of the band to the frame crosspiece and form the other into a clevis as shown.

Extra holes in the brake lever allow for adjustment, and a spring normally holds the band off the drum. Braking action tends to wrap the band around the drum, which makes the brake very responsive.

Engine. For the engine shown, cut four mounts from 1/2" pipe and two straps of 1/8" by 1" stock. These give an inboard support for the engine base, which is narrower than the frame.

The engine comes with a governor, which should be removed. An auto choke cable 72" long is connected to the throttle. Attach a spring to hold the throttle closed unless the button on the handlebars is pushed.

The muffler on this engine interferes with

the drive pulley. Take it off, separate the two aluminum castings, and, using the mounting holes and port in one as a template, mark new ones on the other. Drill and file them out. Plug unneeded holes with bolts and gasket cement, leaving the original cylinder port as the exhaust.

Before mounting the engine, put lock washers under the three screws that hold the crankcase to its base. Tighten the screws hard. You don't want them to loosen under vibration, for they are difficult to reach with the engine in place.

Belt drive. It's the centrifugally controlled pulley, acting as both clutch and variable-ratio drive, that makes the 1-hp. engine perform as well as it does. Some pulleys of this type will serve as a clutch, but offer little or no ratio change. The one I used, a V-Plex clutch model 18T9*, shifts from a drive-belt diameter of 3/4." at rest to one of 2 1/4" at high speed.

The keyway on the engine crankshaft may not be long enough to let the pulley slide close in. To remedy this, grind out one of the two keys cast into the bore of the pulley.

An idler keeps the belt taut. Adjust the pull of the idler spring so that it holds the belt taut over the entire shift range, yet leaves the belt loose when the engine is idling.

[Continued on next page]

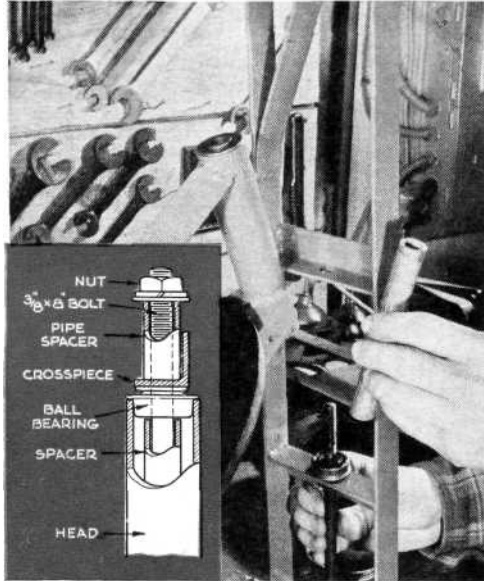

Ends of frame head receive ball bearings like those in the wheels, but with 3/8" hole. Here the lower bearing is on the king bolt over lower fork crosspiece. Spacer held in the hand goes between the bearings inside the head. Short spacer raises nut above top crosspiece for access. Be sure to use lock washer.

The best over-all drive ratio will depend on the kind of roads you travel. In flat country, with 13- and 32-tooth sprockets, a 4" pulley on the countershaft may suffice. In hilly territory, a 5" pulley may be necessary, or you may want a smaller drive sprocket.

Fork assembly. Like the wheel bearings, those in the head should be clamped against a center spacer. Remember to insert

Seat frames are fastened with 1/4" bolts. Make certain the brace in rear frame clears the carburetor amply. Kick stand goes on this end of crossbar. Valve springs, turned over a pair of nuts on each rear frame bolt, rest in shallow holes in plywood seat. The seat must hinge to give access to gas tank.

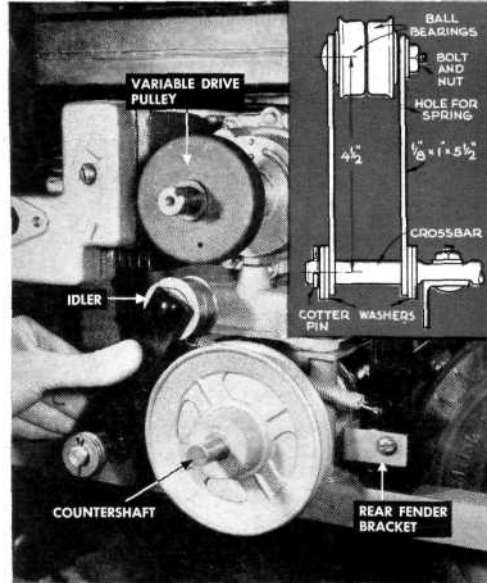
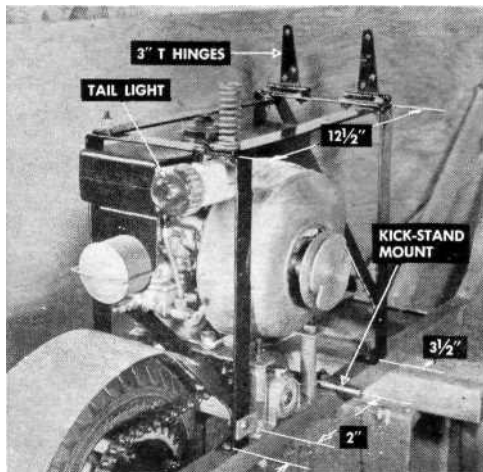

Motor pulley changes flange spacing as engine revs up, changing ratio and also acting as a clutch. Idler takes up belt slack. It consists of two ball bearings bolted to straps that pivot on the crossbar. Muffler has been reversed to clear drive pulley. Its cylinder-mounting boss is now the exhaust opening.

felt washers and dust caps to keep grease in and dirt out. If you can't buy them, you can improvise them from felt rings and 1/2" washers, with a smaller washer inside the felt ring, as shown in the photos.

The trimmings. In fitting the seat support, make certain it clears the carburetor, gas tank, and muffler by at least 1/4" all around. Cut the floor boards from 3/8" or 3/8" plywood, and attach them with 1/4" carriage bolts.

Some states require a tail light, head lamp, and horn before the scooter can be licensed. Battery lights sold for bicycles will serve, but if you want to use a magneto-type (battery-less) lighting outfit that is powered from a wheel, better check its legality in your state.

Trial run. Follow instructions on the engine name plate for mixing oil with gasoline. Always close the fuel petcock and if possible run the carburetor dry (which takes several minutes) when leaving the scooter overnight. Otherwise the carburetor jets are likely to clog with oil, making starting difficult.

Be sure to carry your starting rope at all times. A scooter with a centrifugal clutch can't be started by pushing, although in an

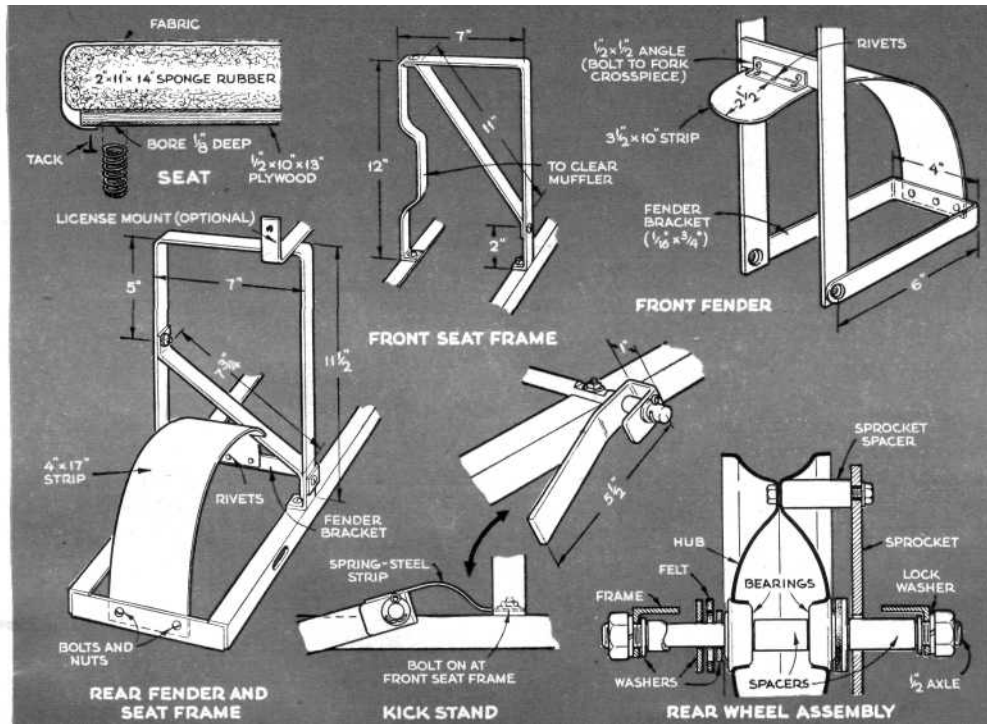

emergency you can probably start the engine with a handkerchief, knotted at one end and twisted into a short starting rope. If the scooter tries to get away from you at low engine speeds, lower the idling speed. Also, check the belt idler tension. Fit a stop to the idler bracket if necessary. On the other hand, failure to "take hold" may be due to too large a belt or insufficient idler tension.

Remember that most belts will stretch after short use, so it's well to start with a slightly tight one.

Up- and down-shifting will be governed in part by the tension of the idler spring, so you may want to experiment with this.

Get your license, practice on some lonely road until you get the feel of the thing, and you're set for happy scooting. **END**

A quick yank starts the engine. Run carburetor dry when you stop, or jets may clog with oil.

