



# PicoTurbine Windmill Plans and Experiments

Building instructions, Teacher's guide, and Technical Notes

An easy to build educational kit for grade 5 through adult.  
For hobbyists, science fairs, schools, home schools, youth  
groups, and experimenters.

<http://www.picoturbine.com>



**WARNING:**

CHOKING HAZARD - Small  
parts, wire. Not for children under  
4 years.

THESE PLANS ARE PRESENTED IN “AS IS” CONDITION. BY USING THESE PLANS YOU HOLD PICOTURBINE.COM, XIBOKK RESEARCH, AND ALL MEMBERS, INVESTORS, EMPLOYEES, AND OWNERS OF THOSE ORGANIZATIONS HARMLESS FROM ANY DAMAGES ARISING FROM THE USE OF THESE PLANS OR THE RESULTING MACHINES. IN NO CASE SHALL PICOTURBINE.COM OR XIBOKK RESEARCH BE LIABLE FOR ANY INCIDENTAL DAMAGES. THESE PLANS ARE NOT WARRENTEED FOR FITNESS FOR ANY PARTICULAR PURPOSE.

Revision 1.1B, August, 1999

[www.picoturbine.com](http://www.picoturbine.com)

## *Support PicoTurbine.com!*

**If you have purchased this document as a part of a PicoTurbine.com kit, we appreciate your support!**

**If you have downloaded this document as a free plan, we hope you enjoy it, and ask that you patronize PicoTurbine.com in the future so we can keep financing new projects. We have a complete line of Renewable Energy books, projects, and kits that are expanding every day. Stop by the web site and buy something! Tell your friends about us! Suggest our projects for youth groups, Scouting Groups, YMCA or similar organizations, classrooms and home schools. The proceeds will be used to support more fun renewable energy projects and kits at PicoTurbine.com. Thanks and have fun!**

Copyright © 1999 PicoTurbine.com. All rights reserved.  
PicoTurbine.com is a wholly owned subsidiary of Xibokk Research.

# CONTENTS

<b>PART 1: BUILDING PICOTURBINE.....</b>	<b>4</b>
BEFORE YOU BUILD PICOTURBINE .....	4
<i>Step 1: Check Your Materials.....</i>	4
<i>Step 2: IMPORTANT: Review Safety Rules.....</i>	5
BUILDING PICOTURBINE .....	6
<i>Step 1: Glue the Template Parts.....</i>	6
<i>Step 2: The Axle and Yoke.....</i>	6
<i>Step 3: Cut Out Parts.....</i>	7
<i>Step 4: The Alternator.....</i>	8
<i>Step 4A – The Permanent Magnet Rotor.....</i>	8
<i>Step 4B – Winding The Wire Loop Stator .....</i>	9
<i>Step 4C: Constructing the Stator .....</i>	9
<i>Step 5 – The Blade Assembly.....</i>	10
<i>Step 6 – Testing .....</i>	10
<i>Trouble Shooting .....</i>	10
<i>If You Still Have Trouble.....</i>	12
<b>PART 2: TEACHER’S GUIDE .....</b>	<b>13</b>
NOTES ON USING PICO TURBINE IN THE CLASSROOM .....	13
RENEWABLE ENERGY EDUCATION .....	13
CLASSROOM EXPERIMENTS AND ACTIVITIES .....	14
<i>Lung Power.....</i>	14
<i>Best Turbine .....</i>	14
ALTERNATIVE DESIGNS FOR PICOTURBINE.....	15
<i>Weatherproof PicoTurbine.....</i>	15
<i>High Power PicoTurbine .....</i>	15
<i>Alternative Blade Designs.....</i>	15
<b>PART 3: TECHNICAL NOTES .....</b>	<b>16</b>
INTRODUCTION .....	16
TYPES OF WIND TURBINE .....	16
ADVANTAGES AND DISADVANTAGES OF VARIOUS DESIGNS.....	16
<i>The table below lists advantages and disadvantages of these major types of wind turbine.....</i>	16
NOTES ON WIND PHYSICS.....	16
<i>Power Available in the Wind.....</i>	17
<i>Very light, flags do not raise .....</i>	17
<i>How Much Power Can We Extract? .....</i>	17
NOTES ON ALTERNATOR PHYSICS .....	18
<i>Voltage Produced by an Alternator .....</i>	18
<i>Amps and Power.....</i>	18
<i>Rectification to DC.....</i>	19
<b>APPENDIX: TEMPLATES .....</b>	<b>21</b>

## PART 1: BUILDING PICOTURBINE

This document will show you how to build PicoTurbine—a fully functioning, electricity-producing scale model of a Savonius wind turbine. The entire project costs only a few dollars, using commonly available materials like magnets, cardboard, tape, wood screws, and a wooden dowel or pencil.

PicoTurbine can be built in about one hour if you have the kit, about 90 minutes if you do not. The kit has the wire coils pre-wound which saves a lot of time. Less time is needed if done as a group project. With some adult supervision PicoTurbine can be assembled by children as young as ten years old, making it an excellent project for renewable energy education.



**PicoTurbine:** about eight inches tall but packed with education!

PicoTurbine stands about eight inches tall—but don't let its size fool you. This version of PicoTurbine produces about one third of a watt of power from a direct-drive single-phase brushless permanent magnet alternator. The design is naturally self-limiting for over-speed protection. I've left models out all night during a windstorm with 50 mile per hour gusts that made my brick house shake. In the morning I looked out my window—fully expecting to see it shredded—only to find PicoTurbine still spinning at top speed in the early morning gale!

### ***BEFORE YOU BUILD PICOTURBINE***

#### **Step 1: Check Your Materials**

The following materials are supplied with your PicoTurbine kit. If you did not purchase a kit but are using free downloaded plans, you must obtain these items from local supply houses:

- ◆ 2 feet of 10-gauge aluminum wire.
- ◆ 400 feet (about 1/3 pound) of 28 AWG enamel coated magnet wire.
- ◆ 4 ferrite magnets, about  $\frac{3}{4}$  inch wide, 1.75 inches long, and  $\frac{3}{8}$  inch thick. Strong ceramic grade-5 magnets are recommended.
- ◆ 1 mini-lamp, 1.5 volt, 25 milliAmps.
- ◆ 1 bicolor light emitting diode (LED) with 2 leads.
- ◆ 3 Phillips head (cross slot) screws.
- ◆ A piece of wooden dowel  $\frac{1}{4}$  inch diameter and 7 inches long. A pencil or long pen will work.

You must provide the following additional materials to build PicoTurbine:

- ◆ An scrap of wood, 8 inches long, about 4 inches wide, and  $\frac{3}{4}$  or more inches thick. A piece of 1x4 or 2x4 works well.
- ◆ A piece of corrugated cardboard about a foot square, perhaps cut from a box
- ◆ Scotch tape and any type of glue.

You also need the following tools:

- ◆ Scissors
- ◆ Ruler
- ◆ Phillips head screw driver
- ◆ Pliers
- ◆ Pencil sharpener

It is also helpful to have the following tools, but not entirely necessary:

- ◆ A digital multimeter that can measure AC millivolts is useful for tuning and testing the alternator, and displaying the amount of electricity produced.
- ◆ Sandpaper is helpful for stripping enamel-coated wires, but if you don't have any handy you can carefully use the blade of your scissors against the side of the 2x4 wooden block.

## Step 2: IMPORTANT: Review Safety Rules

PicoTurbine is not a dangerous project to build, but as with any construction project certain safety rules must be followed. Most of these rules are just plain common sense. Be sure to review these rules with children if you are building this project as part of an educational curriculum.

- ◆ **Adult supervision is required for this project.**
- ◆ **This project is not recommended for children under 10 years old.**
- ◆ **Children must be supervised when working with scissors and other sharp parts to avoid cutting injuries.**
- ◆ **Children under 4 years old should never work with wire or small parts like screws because they represent strangulation and choking hazards. Keep the kit parts out of the reach of small children.**
- ◆ **PicoTurbine generates low levels of electricity (1.5 volts, 200 milliAmps, about 1/3 watt) that are generally considered safe and are of the same order as produced by batteries used in toys or radios. But, to avoid shock hazard never work with electricity of any level when your hands or feet are wet.**
- ◆ **Persons wearing pacemakers should not handle magnets.**
- ◆ **Do not allow magnets to “snap” together or fall together. They are brittle and may chip or break. They can also pinch your fingers or send small chips flying through the air, presenting an eye hazard.**

PicoTurbine kits should not be carried onto aircraft, because strong magnets are generally not allowed on airplanes, and because the materials used in PicoTurbine look a lot like those used for illegal devices, which could cause you delays in check-in.

## **BUILDING PICOTURBINE**

### **Step 1: Glue the Template Parts**

At the end of this document the Appendix contains templates for the cardboard parts. Carefully cut these out and glue them to pieces of corrugated cardboard. Any normal cardboard box will do. The template marked “Rotor” with the four square magnet outlines marked “N” and “S” should be glued to a doubled-up piece of cardboard. The two pieces of the doubled cardboard are glued together as well. Set these glued pieces aside to dry while you continue on to the next step.

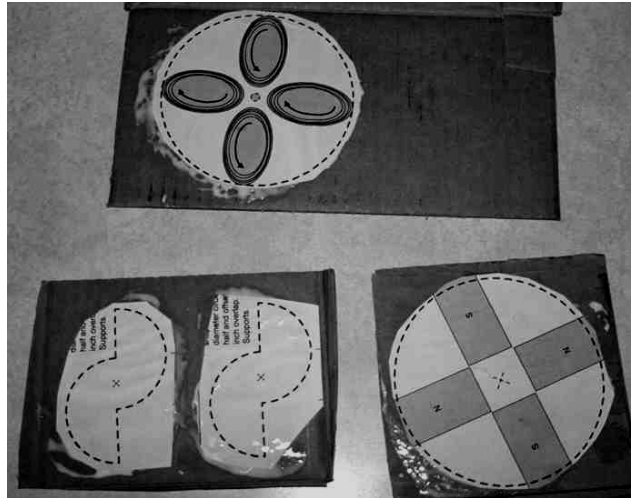

**Templates glued to cardboard.** The rotor template on the lower right side of this figure is glued to a double thickness of cardboard made from two glued pieces about 4 to 5 inches square.

### **Step 2: The Axle and Yoke**

There is a common axle used by both the blade assembly and the alternator, made from a wooden dowel. The dowel is sharpened on one end using a pencil sharpener. The dowel's point rests in the center groove of a Phillips head screw, and the blunt end is held by a wire loop. See the figure below.

To make the base and yoke assembly, start with the heavy, 2-foot section of wire. Using pliers, bend a small loop on one end. Bend the loop so it forms a 90-degree angle with the rest of the wire. Measure 6 inches up from the loop and make a 90-degree bend in the wire. Measure 3 inches from this bend and form another loop, slightly larger than the diameter of the dowel. Measure 3 inches from the center of this loop and make another 90-degree bend, forming a large, square, U shape with the wire. Measure 6 inches from this bend, and form another loop. Clip off any excess wire. The U shaped piece of wire will be called the “yoke”.

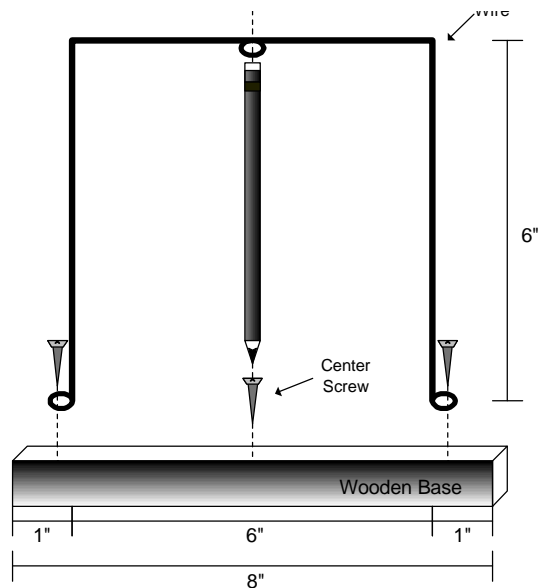

Fasten the yoke to the wooden base using two screws. The legs of the wire yoke should be centered on the wide face of the wood as shown above. Insert the dowel in the center hole of the yoke and rest the point in the center screw's groove. The dowel should stand as near vertical as possible. Adjust the yoke by bending the wire if necessary to make the dowel vertical both side to side and front to back. Make sure the dowel turns freely in the yoke's center loop. If you wish, you can put a drop of any type of oil in the center screw's groove to make the dowel turn more freely.

### Step 3: Cut Out Parts

Cut out the Blade Coverings from the templates. The blade may be colored or decorated using crayons or markers at this time. If you are constructing this in a mixed group then this is a good task for younger children. The ends of the blade coverings should be carefully cut into a "feathered" edge. See the figure below.

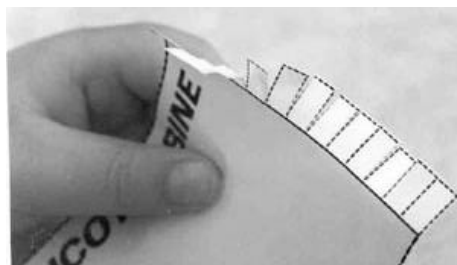

**Feathered Edges.** Cutting carefully on the dotted lines will create a feathered edge that is more easily assembled.

If the previously glued templates are dry enough carefully cut them out. The complete set of parts you need for further assembly is shown below.

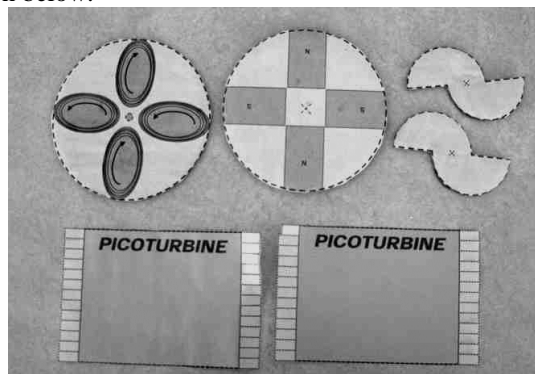

**Complete set of parts.** The items on the top row are glued to cardboard.

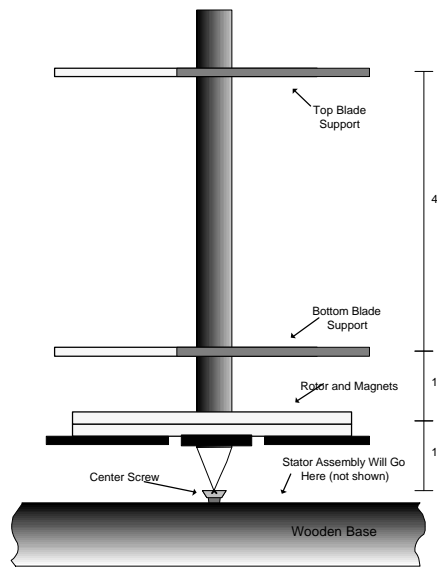

### Step 4: The Alternator

An alternator is little more than magnets moving relative to wire loops. The magnetic flux density changes as the magnets (or wire) move around, inducing an electric current in the wire. In PicoTurbine, the magnets will spin on an assembly called the rotor, while the wires will remain motionless on a part called the stator. See the figure above.

The alternator is by far the most challenging part of PicoTurbine to build. If you build it carefully, you can achieve about 2 to 2.5 volts of electricity at about 30 milliamps in a 20 mile per hour wind. This is enough electricity to light up the small incandescent lamp and the bicolor LED provided in the kit.

### Step 4A – The Permanent Magnet Rotor

Tape the four magnets as on the rotor template as shown below. Note that the magnets are magnetized on their faces, and you must alternate poles going around the diameter. Remember that like poles repel, and opposite poles attract. If building this project with children, your best bet is to mark the poles using a pencil or marker before beginning. Magnets distributed with your kit are already marked with a dot on one pole. So, you should alternate: dot, no dot, dot, no dot.

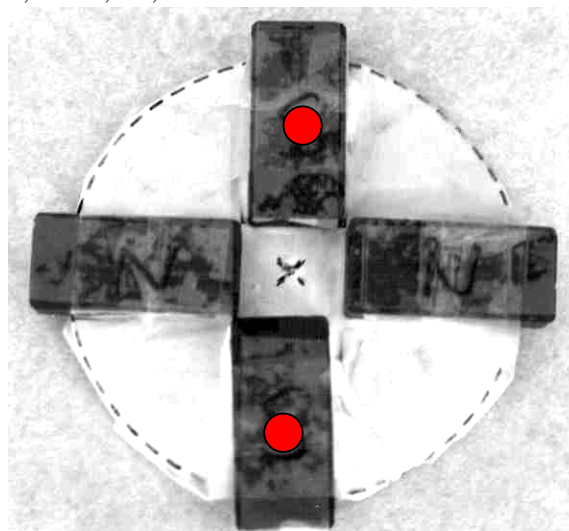



Poke the dowel through the rotor as shown, being careful not to break the point. Work it down slowly so as not to stretch the hole bigger than needed, it must be quite tight. Use some tape to make sure there is a tight fit.

You can use the two rotor support tabs shown on the template to make a stronger connection. Simply cut two small slots next to the center hole of the rotor and insert the thinner side of the tab up from the magnet side. The slots should be narrower than the bulbed portion of the support tab. It is easy to affix tape to the top of the tabs to prevent the rotor from sliding down the dowel.

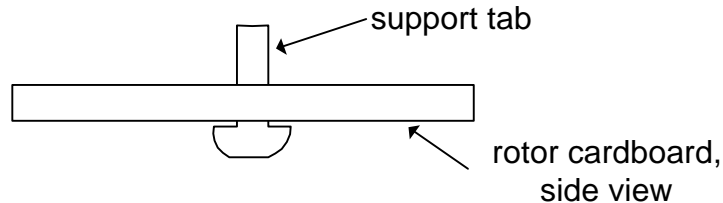

Place the dowel top up from the bottom into the yoke loop, pull it through, and lower the point into the center screw. Spin the rotor by twisting the blunt end between thumb and forefinger. It should spin freely, and vertically. Adjust the wire yoke if necessary. Watch the rotor as it spins. It should spin evenly, with as little wobble as possible. Adjust it and use tape if necessary to fix it in place. If you give it a good spin, the rotor should spin on its own for quite a long time, 30 seconds or more. The ballpoint is an excellent bearing and there is very little friction. The yoke loop should not be too tight around the dowel.

#### Step 4B – Winding The Wire Loop Stator

If you have the PicoTurbine kit, then the wire loops are already wound for you and you can skip this section.

Otherwise, take a piece of cardboard 1.5 inches wide and six inches long, and fold it, resulting in a piece about 1.5 inches by 3 inches and double the normal thickness. Tape this together so it holds. This is your wire-wrapping tool. Take your supply of 28 AWG wire. Reserve about four inches start wrapping loops around the 1.5 inch dimension. Make 300 turns of wire around your cardboard wrapping tool. Leave four inches after the last turn. Then, carefully slide the wire off the tool and immediately wrap tape tightly around the bundle of wire so it doesn't spring apart. The tighter you can form the bundle, the better. You will have a slightly oblong coil of wire, about 2 inches long and about 1 inch wide. Do this four times, creating four coils.

Test each loop to ensure it functions. Strip about an inch of wire from each end, using the blade side of the scissors or sandpaper. If you have a multimeter, set the it for AC millivolts. Holding the loop close under the magnet section of the axle/rotor assembly, give the rotor a good spin. If you spun hard and are holding the loop close to the magnets you should see 400 to 600 millivolts from a single coil.

#### Step 4C: Constructing the Stator

Strip the ends of the wires coming out of the coils. Stripping is best performed with fine to medium sandpaper, but you can also carefully use a knife or a scissors blade. Make sure the stripped wire is shiny copper, with no red enamel remaining. Affix the coils to the stator template as shown by the coil drawings. Note that the loops should alternate between clockwise and counter-clockwise rotation. If you are using the PicoTurbine kit, this means the part of the loop where the leads come out should alternate being near the edge of the cardboard and being near the center. Tightly twist together the stripped wires from one coil to the next, leaving the final two wires (the first and last) unattached. Attach the coils using tape. They should lie very flat. Cut a circle in the center of the stator cardboard. Remove the rotor/axle assembly by pulling up on the blunt end and angling it out. Put the stator assembly over the center screw, and tape it down firmly. It will slightly overhang the ends of the wood in front and back. Put the rotor/axle back on. There should be as little gap between the coils and magnets as possible, but not so little that there is any chance of the

magnets crashing into the coils when you spin them. Adjust the center screw to adjust the height of the rotor magnets over the wire.

Now, hook the two remaining wires to your multimeter and give the rotor a spin. If you spin fast, and everything is aligned well, you should get about 1.2 to 1.5 volts (or more if you've built very well).

## Step 5 – The Blade Assembly

You're almost finished! This is easy compared to the alternator. Cut the two blade supports out, and poke an X in their centers. Slide them onto the dowel from the blunt side. They should be aligned with each other, don't turn one upside down accidentally.

Glue each paper blade covering on the circular side of the blade support, both top and bottom. Use the feathered edges to negotiate around the circular support. The final effect is as if you took a cylinder, cut it lengthwise, and offset the two halves horizontally before fastening them back together.

Put tape along the two leading edges, and tape over the glued top and bottom parts just for good luck in high winds.

## Step 6 – Testing

Carefully insert the blade/rotor/axle assembly back into the yoke. Blow into the blades from any direction, and they should start up very easily. Short, puffing blows are best. Hook up your multimeter again and blow in some wind. If you have very good lungs you'll get a couple of hundred millivolts, the wind will do much better than you!

For classroom demonstrations a small fan or hair blow dryer can provide the wind. Finally, if it's a windy day give it a real test using Mother Nature. Attach the mini-lamp to the leads and carefully twist them tight. In a wind of about 10 to 15 miles per hour the lamp will glow weakly, in a 15 to 20 mile per hour wind it will glow quite brightly.

Now try the LED. This is a bicolor LED. When current flows in one direction, it will glow green. In the other direction, it will glow red. Because PicoTurbine creates alternating current, it will go from green to red and back again many times per second. PicoTurbine needs to produce a minimum of about 1.5 volts to start the LED glowing, somewhat more than is required to produce a weak glow from the incandescent lamp. To produce this much power, it must turn about 3 to 4 cycles per second. A good spin with your fingers will produce this rate of turning, or a hair dryer positioned very close to the blades, or a wind of about 15 miles per hour.

## Trouble Shooting

This section discusses some common problems and how to fix them. Look through this section and try out everything suggested. If you still cannot get the kit to work, send electronic mail to [support@picoturbine.com](mailto:support@picoturbine.com) and we'll give you a hand. This section discusses the most common problems.

### **Problem: Blades Do Not Spin, or Only Spin Slowly**

1. **Yoke Too Tight.** Make sure the top of the wire yoke loop is loose enough. The dowel should be able to move slightly left and right, and should be able to turn freely. If not, use pliers to form a larger loop.
2. **Rotor/Stator Collision.** Make sure the magnets are not hitting the coils or a stray piece of tape or wire lead. If a piece of tape has come loose, clip it off or use more tape to hold it down. If the magnets are hitting the coils, move them slightly farther away and affix tightly with tape. If the magnets tend to sag to one side, then you may have to add another 4 inch cardboard disk glued to the top of the rotor to reinforce it.
3. **Bad Point.** Make sure the dowel point is reasonably sharp. If the point keeps breaking, try using a pen instead. A pen never has this problem, but most pens are a little short of the required length. You may

have to shorten the blade height to accommodate a pen, unless you can find one that is a bit longer than usual.

4. **Ribbed Pen.** If you are using a pen that has “flat” edges, this can sometimes cause too much friction on the upper yoke loop. Try using a perfectly round pen instead of one that is flat.

### **Problem: Lamp Lights but LED Does Not**

The lamp will light with somewhat less voltage than the LED. If the lamp lights weakly but the LED will not light up, then you have just barely enough voltage to light the lamp. The most likely causes of this are:

- The magnets are too far away from the coils to produce enough voltage, or
- There is friction that is causing the PicoTurbine to spin too slowly, or
- The coil connections are not tight enough and causing too much resistance in the circuit.

### **Problem: Neither Lamp nor LED Light Up**

1. **Lamp Burned Out.** Make sure the lamp is working by touching its ends to opposite sides of a 1.5 volt AA battery. It should glow nicely. Be sure the battery is new or test it in some device.
2. **Coils Lack Continuity.** Make sure the coils are connected well. If you have a multimeter that can test continuity or has an Ohms test, then hook one end of each alternator lead to the multimeter. A continuity check should pass. A resistance check should show approximately 32 ohms for the four coils, or about 8 ohms for a single coil. If the resistance check shows more than 40 ohms, or shows infinite resistance, then your coils are not properly connected. If you do not have a multimeter, check continuity by using the supplied lamp and a 1.5 volt AA battery. Connect the coil leads to the battery and lamp in series as shown in the diagram below.

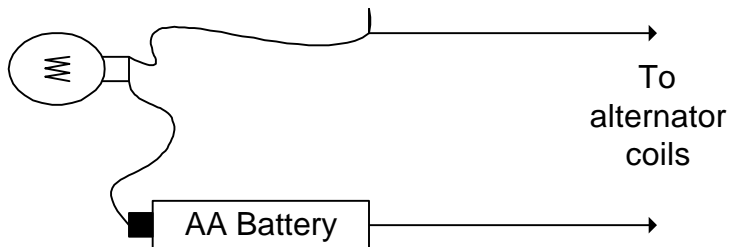

The lamp should light (assuming the lamp is good as shown in (1) above and the battery is known to be good). The most common cause of coil problems is that the wire leads are not properly stripped. Strip each lead using sandpaper, or carefully use the edge of a knife or scissors edge. Strip about 1 inch. The stripped part should look like shiny copper with no red enamel coating at all. Tightly twist together the leads from the coils and check continuity again using a multimeter or the lamp with an AA battery. If you still cannot get a positive continuity check using multimeter or lamp, then there is a possibility that a coil is broken or kinked. To test this, disconnect all the coils from each other and test continuity on each one individually. If you find that one coil is bad, then double check that the ends are properly stripped. Inspect the coil visually and look for damage such as kinks or breaks in the wire. If you locate a break, then strip the ends of the two broken pieces and tightly twist them together, then put a little tape around the twisted pieces.

3. **Coils Not Placed Properly.** Double-check that the coils are properly aligned. The coils must alternate direction, otherwise they will cancel each other out. Look carefully at the stator template diagram, and make sure the leads coming out of the taped portions alternate between pointing toward the center and pointing toward the radius, and make sure the wires are connected as shown. For your convenience, a smaller version of the diagram is shown below (in case you can't see it because it's taped over). Notice how the wires come out from the black tape. As you look at coils clockwise from the top, you see first a coil where the wires exit the tape toward the radius, then toward the center, then toward the radius again, then the center again.

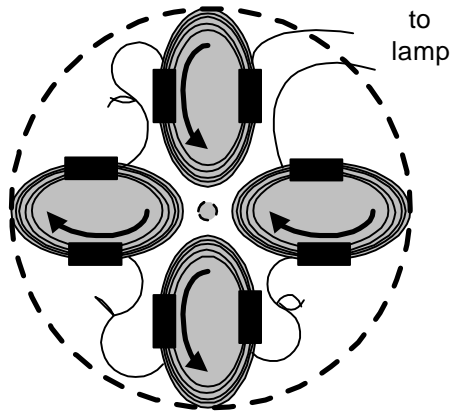

4. **Magnets Not Placed Properly.** The magnets must also alternate going around the rotor. A dot is imprinted on one side of each magnet. The magnets should alternate going around: dot, no dot, dot, no dot. Another way of saying this is that the magnets with dot side up will be directly opposite one another, and the magnets with dot side down will be across from each other as well. If you don't do this, then power from the alternator may not be high enough to light the lamp and definitely will not light the LED.

### If You Still Have Trouble

If you still cannot get PicoTurbine to work after following all of the above suggestions, you may have a defective or damaged part. Send email to [support@picoturbine.com](mailto:support@picoturbine.com) describing the problem and we'll help you out.

## PART 2: TEACHER'S GUIDE

### ***Notes on Using PicoTurbine in the Classroom***

PicoTurbine makes an excellent small group project for grades 5 through High School. For the younger grades (5 and 6), it is recommended that the teacher perform some or all of the following parts of the construction in advance of the class in order to save time:

- If you are not using the kit, wind the four coils of wire in advance. Younger children may tangle the wire and possibly break it.
- Bend the yoke wire into the U shape. Children below about grade 7 or 8 may not be able to do this accurately enough.

It is also recommended for grades 5 and 6 that the teacher handle the screwdriver to screw the yoke to the wooden board and install the center screw.

By performing this as a small group project, it is possible to complete the project in about 30 to 40 minutes, however to do this you must use a quick-drying glue for gluing the template parts to the cardboard. However, for safety reasons we do *not* recommend “super glue” (cyanoacrylate glue) because it could bind fingers and eyelids closed if used improperly.

Alternatively, you could use glue and also tape the edges after gluing. In this way, if the glue is still slightly wet later in the project you can still proceed. Alternatively, you could glue the parts in advance, or break the project across several periods (do the gluing and yoke in a 20 to 25 minute session in the morning, and complete the project in a 20 to 25 minute session in the afternoon when everything is dry). Of course, the project could also be broken across two days.

A reasonable set of tasks that can be done simultaneously by a group would be:

- One person cuts out templates and glues them to cardboard.
- Simultaneously, another group member bends the yoke wire and prepares the base screws.
- Simultaneously, if you are not using the kit, another group member winds the four wire coils. Two group members could be assigned this task if there are enough people.
- After the above tasks are complete, one member attaches the blade coverings to the blades while another attaches the magnets to the rotor and a third attaches the wires to the stator.
- Finally, the project is assembled by the group.

### ***Renewable Energy Education***

PicoTurbine is an excellent project to supplement science and environmental lessons. It is especially relevant during Earth Day celebrations.

Here are some fun facts about wind power as a renewable energy source that you can use in your curriculum.

- Germany is currently the number one producer of wind powered electricity in the world. As of 1999, Germany had 4,000 megawatts of installed wind capacity, as much as two large nuclear power plants. The United States has about 2,500 megawatts of installed wind capacity. Most “wind farms” in the USA are located in California, and they may have dozens, and in some cases thousands of windmills. The Netherlands and Denmark also have aggressive plans to increase wind power in their countries.
- Commercial sized wind electric generators can produce between 100,000 and 1 million watts of power, as compared with little PicoTurbine which produces well under 1 watt.

- Wind power has been used for thousands of years. Early designs were used in Mesopotamia to grind wheat. Grinding and pumping water were the two biggest uses of windmills before the 20<sup>th</sup> century. Even today, thousands of water pumping windmills are used in the central and western portions of the USA, saving millions of tons of pollution and providing water in remote areas.
- There is enough wind in two states (Texas and Oklahoma) to produce all the electricity used in the entire USA if it were fully developed.
- Wind power and hydro-electric power are currently the only alternative energy sources that are clearly competitive in cost with fossil fuel electricity generation. Solar electricity is still more expensive than fossil fuel generation. However, fossil fuels cause pollution, so proponents argue there is a hidden cost that will be paid by future generations for burning fossil fuel.
- Wind and Solar power are very complementary renewable electricity sources, and are often used in combination for power in remote areas. For example, the sun is less intense in the winter, but wind is usually stronger in the winter. The sun doesn't shine during rainstorms, but the wind is usually higher during storms.
- The United States has a goal to produce at least 2% of all electric power using Solar and Wind within 10 years. Currently, hydro-electric generation produces about 10% of all power in the USA.
- Wind generators do not produce any chemical pollution, but they do produce some "noise pollution." For this reason, large commercial wind farms are usually placed away from heavily populated areas. Scientists are working to reduce the noise levels of the whirling blades (great strides have been made in the last 10 years or so).

### ***Classroom Experiments and Activities***

Here are some experiments and classroom ideas you can perform with PicoTurbine.

#### **Lung Power**

If you have a multimeter that displays DC millivolts, you can have a lung power contest. Allow each child to puff on PicoTurbine from a distance of several inches for up to 10 seconds. The teacher watches the multimeter, and whatever the highest reading was during the 10 seconds is the score for that child. Best lung-power wins!

#### **Best Turbine**

If several different PicoTurbine units have been built by a class, then you can have contests and award prizes. Some ideas are:

- Most electricity. Using a hair dryer and a multimeter, see whose model produces the most electricity under the same conditions. Make sure the dryer or fan is at the same distance for each contestant. If you don't have a multimeter, judge which machine lights the mini-lamp the brightest.
- Smoothest motion. The teacher judges whose model has the smoothest operation and least wobble when spinning.
- Lowest start-up speed. See whose model will start up in the lowest wind speed. This is judged by using a hair dryer set at different distances from the PicoTurbine. The PicoTurbine that spins with the dryer the farthest away is the winner (the wind speeds drops quickly with distance from the dryer).
- Best construction. The teacher judges whose machine is the neatest looking and most finely crafted.
- Best Blade Coloring. The teacher judges whose machine has the nicest blade coloring design. Clever designs might look nicer when turning, for example a "barber pole" stripe design. This contest is good for younger children in mixed grade level classes.

## **Alternative Designs for PicoTurbine**

This section provides some design alternatives for PicoTurbine for experimenters and perhaps science fair projects.

### **Weatherproof PicoTurbine**

PicoTurbine, as described in the main plans, is not weatherproof. The tape, glue, paper, and cardboard will quickly disintegrate in rain. Here are some ideas to produce a weatherproof PicoTurbine that can be left outdoors. It will be harder to build, but worth the effort.

- Instead of paper, use a large plastic bag for the blade covering. An alternative is to use a material such as Tyvek™ for the blade covering, which can be purchased at hobby stores, or plastic materials used for kites.
- Instead of cardboard, use 1/8 inch plywood or corrugated plastic for the blade supports, rotor and stator. Plywood must be cut with a coping saw or keyhole saw. Corrugated plastic may be purchased at art supply or sign supply stores and can be cut with a razor blade or sharp knife. Only adults should do the cutting!
- Instead of tape and glue, use epoxy glue or weatherproof tape. These can be purchased at hardware stores. Epoxy glue should only be used by adults.
- Use small wire nuts to secure the lamp to the leads so the rain does not touch the contacts.

### **High Power PicoTurbine**

To make a higher power version of PicoTurbine, follow these instructions:

- Make the Blade coverings 6 inches tall instead of 4 inches.
- Use a 1 foot long ¼ inch threaded rod instead of a wooden dowel. Obtain 6 nuts and 6 large washers to use to attach the rotor and blade supports.
- Use 6 magnets instead of 4. Equally space the magnets and remember to alternate north and south poles.
- Attach the magnets to a 1 gallon paint can lid. This provides a metal backing to the magnets and increases the magnetic field strength somewhat. Use double sided tape or epoxy glue to affix the magnets. If you have magnets with holes in them you could also use screws.
- Use 6 coils instead of 4.
- This version produces about 1 full watt. Warning: the mini-lamp can't handle the voltage that will be produced. Obtain a 3-volt flashlight lamp or put 2 lamps in series. To use the LED, you must put a small resistor in series with the LED to limit the current, otherwise you will burn it out as well. Use about a 200 to 400 ohm resistor.

### **Alternative Blade Designs**

As shown in this document, PicoTurbine uses a traditional “barrel offset” blade design. But, blades can be offset more or less. Also, the curved portion can be a shallower or deeper curve. Play around with the shape of the blade support parts and test these to see which is more efficient. This would make an excellent science fair project. It would even be possible for an advanced student to look up patented designs for Savonius wind turbines (that's the kind PicoTurbine is) and do a study of which one is best. To do this, go to the website: <http://patents.ibm.com> and search for “Savonius”. You will get quite a few patents back. Look at the blade design described in the 1996 patent by Benesh. It claims to be much more efficient than the one used in PicoTurbine. Put it to the test!

Note: it is not illegal to build a model of a patent for personal testing purposes, it is however illegal to use it commercially without permission. So, you can build the design described in this patent, but you cannot sell it to anyone!

# PART 3: Technical Notes

## Introduction

These technical notes may be useful for science fairs or for adult hobbyists and experimenters. Science background equivalent to high school level physics would be useful for some sections, but most don't even require that.

## Types of Wind Turbine

There are three main types of wind turbine:

- **Horizontal Axis Wind Turbine (HAWT)**  
This design uses lift, like an airplane wing, to produce torque. This is what most people think a windmill looks like.
- **Vertical Axis Wind Turbine (VAWT) – Drag based**  
This design is used in the PicoTurbine project. Specifically, the design is called the Savonius turbine, after it's inventor, S. I. Savonius. It was invented in the 1920's. It uses drag, like a cup anemometer, to produce torque. Because it is horizontal there is no need to have a mechanism to keep it turned into the wind.
- **Vertical Axis Wind Turbine (VAWT) – Lift based**  
This design uses lift, but is vertical in design. Examples include the Darrius "egg beater". These designs are in commercial use, but no longer in commercial production. There are several hundred still in use for commercial power generation in California and elsewhere.

## Advantages and Disadvantages of Various Designs

The table below lists advantages and disadvantages of these major types of wind turbine.

Design	Advantages	Disadvantages
HAWT	<ul style="list-style-type: none"> <li>• Most commercial machines use this design because it is well understood.</li> <li>• High efficiency: about 40% efficient, not too far from the theoretical limit of 59%.</li> <li>• Relatively low material costs because blades are few (2 or 3 usually) and thin.</li> </ul>	<ul style="list-style-type: none"> <li>• Complexity is increased because the blades must be turned into the wind by a "yaw" mechanism.</li> <li>• Alternator must be atop a tall tower, thus is hard to access for maintenance.</li> </ul>
Drag based VAWT (Savonius)	<ul style="list-style-type: none"> <li>• Easy to build (PicoTurbine is a Savonius VAWT)</li> <li>• Few moving parts, no "yaw" mechanism needed</li> <li>• Slow speed of rotation means parts don't wear out as fast.</li> <li>• Alternator is near ground level.</li> </ul>	<ul style="list-style-type: none"> <li>• Lower efficiency. Estimates range from 15% to 24% efficient as compared to 40% for other designs.</li> <li>• More material needed to build, because the blades are totally covered.</li> </ul>
Lift based VAWT (Darrius)	<ul style="list-style-type: none"> <li>• Few moving parts, no "yaw" mechanism needed.</li> <li>• High efficiency. Nearly 40% efficient.</li> <li>• Alternator is near ground level.</li> </ul>	<ul style="list-style-type: none"> <li>• Blades travel at near sonic speeds (500 to 600 miles per hour) and thus are under a lot of stress.</li> <li>• Design is less well understood.</li> </ul>

## Notes on Wind Physics

This section is for high school students and adult experimenters. Some parts require knowledge of high school level mathematics.



## Power Available in the Wind

The power that is available in the wind depends on the wind speed, the density of the wind (which varies with altitude and temperature), and the amount of turbulence (swirling) in the wind. Turbulence is difficult to quantify, but in general it detracts from our ability to extract mechanical energy from the wind. For this reason, wind turbines are typically installed as far above ground level obstacles as possible, since trees and buildings both add to turbulence and detract from wind speed.

The power available at a given wind speed can be approximated by using the following formula:

$$P = \frac{1}{2} \rho v^3$$

Where:

- P is power in Watts per square meter of wind. Imagine a “window” one meter square through which the wind passes, P measures the power available sweeping through that window.
- $\rho$  is the density of air in Kilograms per cubic Meter.
- v is the velocity of the wind in meters per second. There are about 2.2 miles per hour in each meter per second.

The density of air at sea level and room temperature is approximately 1.3 kilograms per cubic meter. This is more than most people would guess. It means a cube of air a little more than one yard in each dimension would weigh just under 3 pounds.

Note that the power depends on the cube of the velocity. This means each time you double the wind speed you increase the available power by a factor of 8. The following table gives approximate power available for some common wind speeds (all values are rounded for ease of reading):

Wind Speed (MPH)	Wind Speed (Meters/Second)	Wind Description	Power Available (Watts)
2	1	Very light, flags do not raise	Less than 1
5	2	Small branches on trees move slightly	5
10	4.5	Small branches move, leaves are lifted off ground	60
15	6.5	Large branches move, flags flap vigorously	175
20	9	Trees in full sway	475

As you can see, there is very little available power below 10 MPH, but as wind speed increases the power becomes very significant.

## How Much Power Can We Extract?

We cannot necessarily get at all the power in the wind. In the early 1900's a German researcher named Albert Betz reasoned that if you extracted all the energy from the wind then the air would stop moving near the wind turbine, and thus air coming in downstream would be blocked. Using an elegant argument based on conservation of momentum and conservation of energy, he derived that the most you can possibly extract is 59.25% of the available power. This is called the Betz limit. So, even though there are about 60 watts of power available per square meter in a 10 MPH wind, the best you can do is to extract about 35 watts.

In practice, no wind turbine has ever achieved the Betz limit. Most commercial turbines are about 40% efficient at converting wind to mechanical energy. Then, there are additional losses converting that mechanical energy to electrical power. The best alternators are about 90% efficient, there are also frictional

losses in the drive train and bearings, and power conditioning losses. Overall, commercial machines end up being between 25% and 30% efficient.

Commercial wind turbines used for power production on a large scale sweep huge areas of wind. Sometimes the turbine blades are over 100 feet in diameter. In addition, they are placed in very windy places. Typically the average wind speed suitable for a “wind farm” would be at least 15 miles per hour. Small wind turbines used at homes and farms can operate successfully in places with average wind speeds as low as 9 miles per hour and typically have blades that are between 5 and 20 feet in diameter. About half of the continental USA has wind speeds high enough for successful small home or farm systems.

### **Notes on Alternator Physics**

This section is for high school students and adult experimenters. It requires some knowledge of high school level physics concepts.

### **Voltage Produced by an Alternator**

A permanent magnet alternator is simply a set of magnets moving relative to wires. Electric current is induced in the wires in a phenomenon that has been known since the days of Faraday. The voltage produced is alternating current (hence “alternator”) and follows a classic sine wave pattern. The level of maximum (peak) voltage produced is approximated by the following equation:

$$V_{\max} = NARP/2$$

Where:

- N is the number of loops of wire.
- A is the area enclosed by a loop of wire, in square meters.
- R is the rotational velocity of the magnets, in cycles per second.
- P is the number of magnet poles per cycle.
- B is the strength of the magnetic field of each pole, in Tesla.

The magnets used in PicoTurbine have an intrinsic strength of about 0.39 Tesla. However, there is an air gap between the magnets and the wire loops. The magnetic field intensity drops off quickly in an air gap. If the air gap is around a quarter inch, then the field would be approximately 0.28 Tesla. The area enclosed by a loop of wire in PicoTurbine is about 2.5 centimeters by 4 centimeters, or about  $1 \times 10^{-3}$  square meters. PicoTurbine has 4 magnetic pole changes per cycle. It has 1,200 loops of wire.

Let’s say PicoTurbine spins at 4 cycles per second. Then, an estimate of the peak voltage would be:

$$\begin{aligned} V_{\max} &= (1200) * (1 \times 10^{-3}) (4) (4) (0.28) / 2 \\ &= 2.688 \text{ volts} \end{aligned}$$

However, this is the peak voltage. A digital multimeter in AC volts mode will display the root mean square (RMS) voltage. For a sine wave, this will be the peak voltage divided by the square root of 2, which is about 1.41. So, a multimeter will read out about  $2.7/1.41$  or 1.9 volts in this case. In practice, you will see somewhere between 1.8 and 2.5 volts depending on how well you have built PicoTurbine and precisely how fast its maximum speed is. Most critical is how small the air gap is, and how little “wobble” there is. A larger air gap will rob the magnetic field of strength, and wobble will make the conversion efficiency of the wind to mechanical energy lower.

### **Amps and Power**

The wire in PicoTurbine has a resistance of about 32 ohms. Amperage is voltage divided by resistance. So, if we get 2.0 volts RMS, then we expect about  $2.0/32 = 62.5$  milliAmps.

Power is voltage times amps. So, power would be about  $2.0 * 0.0625 = 130$  milliWatts, or about a sixth of a Watt. However, this is the power with no load. The maximum power that can be output by an alternator

occurs when the load resistance is equal to the internal resistance. So, if we put a 32 ohm load (about 1 mini lamp) on PicoTurbine, it would actually only deliver about 1/12 Watt overall, and only half of that would actually make it out to the load. The rest would dissipate as heat in the PicoTurbine wires.

## Rectification to DC

PicoTurbine produces AC power. AC power is fine for things like lights or heating elements, but DC is needed for most electronic devices. PicoTurbine can be made to produce DC by feeding its output through a diode. Because diodes cause a further voltage drop, and we are already dealing with small amounts of voltage, we must choose a diode with very little drop. A proper choice would be either a germanium diode or a Schotky diode, each of which have drops below a half volt. The output must further be smoothed out using a capacitor because it follows a sine wave and we need a steadier current. In fact, several capacitors and diodes would be used in a real rectifier circuit.

To do experiments with DC power, you can obtain the PicoTurbine-DC kit (or free plans) at <http://www.picoturbine.com>. That kit includes diodes, capacitors, and a solderless breadboard along with other items to help you perform DC and AC experiments with PicoTurbine's power.



## **Appendix: Templates**

The templates on the following pages are actual size. As shown in the instructions, some of them are to be affixed to cardboard before using. You may want to make copies of the templates before using them in case of error.

There are intentionally blank pages on the flip side of each template so you may directly use these pages if you wish.



# PicoTurbine Blade Support Template

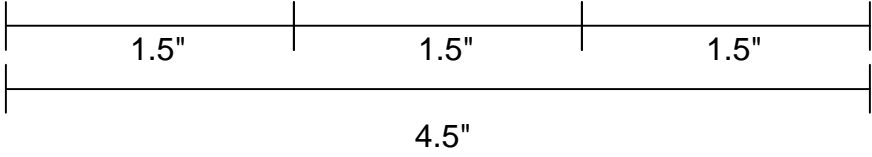
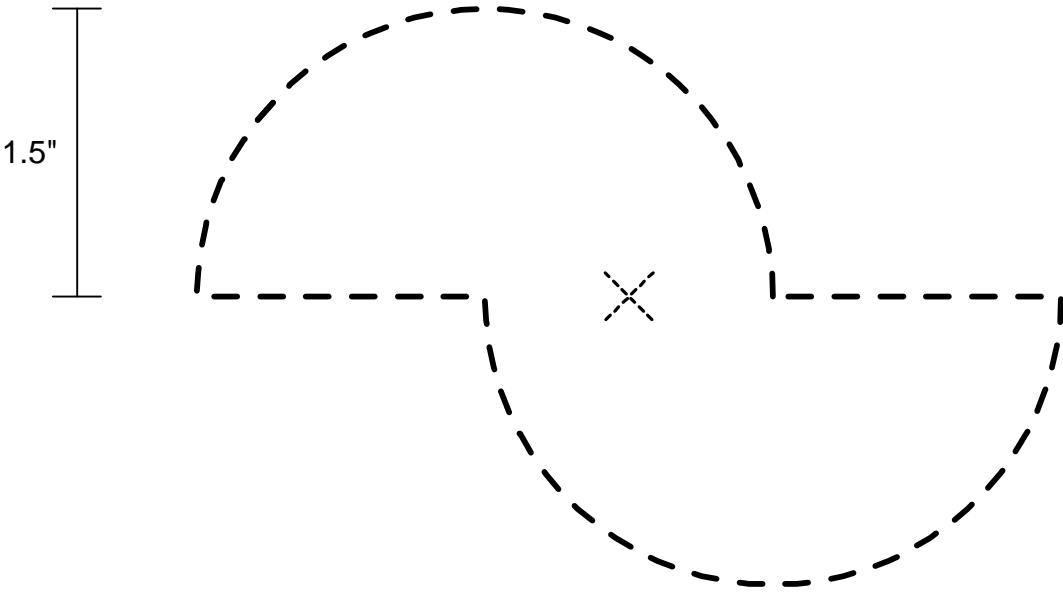
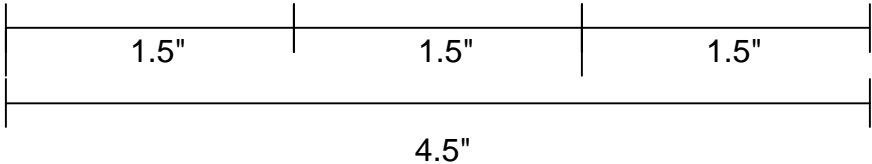
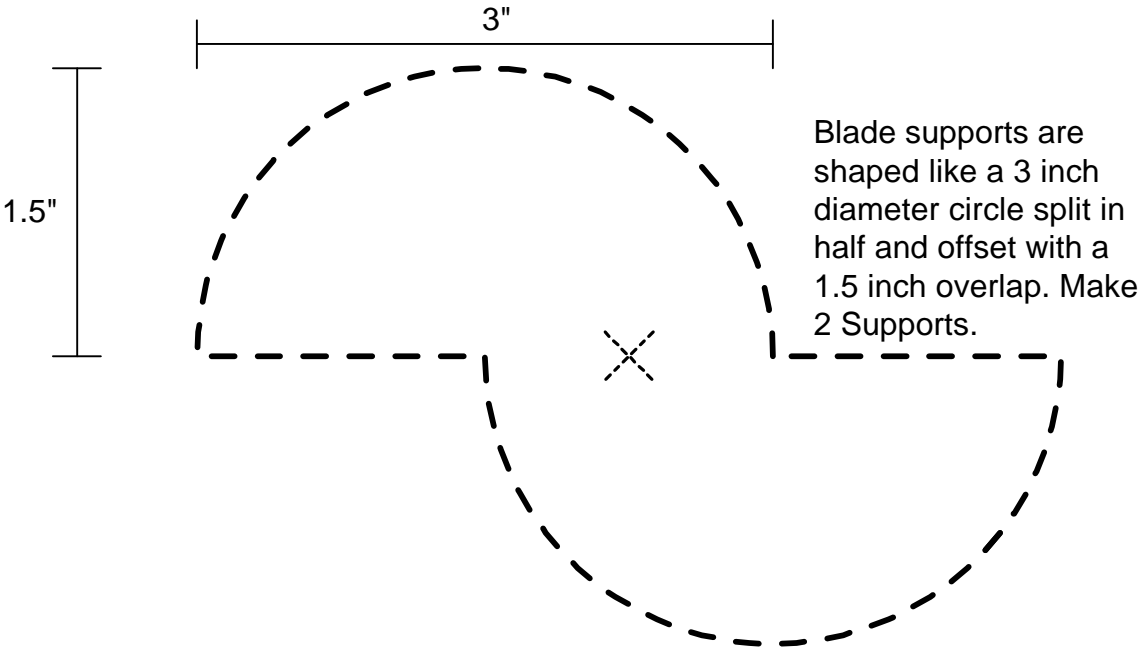





# Stator Cardboard Template

(arrows show direction of wire winding)

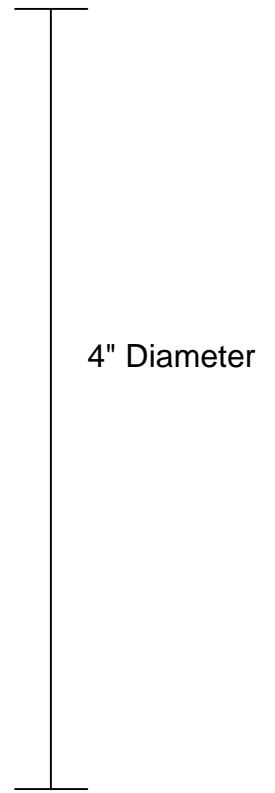
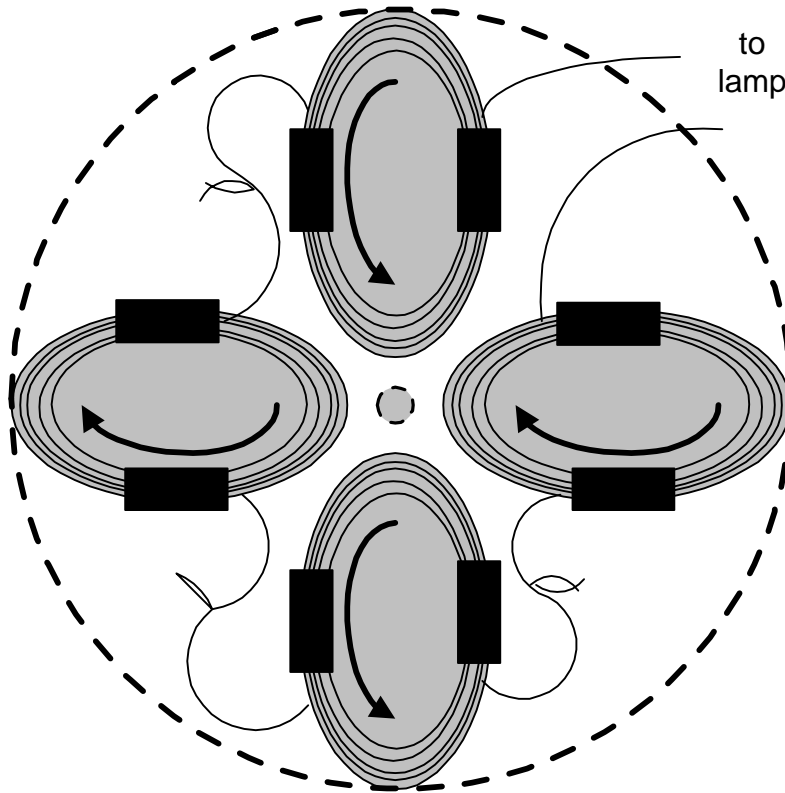

# Rotor Cardboard Template

(letters show magnet pole face)

Magnets are approximately 1.75" by 0.75"

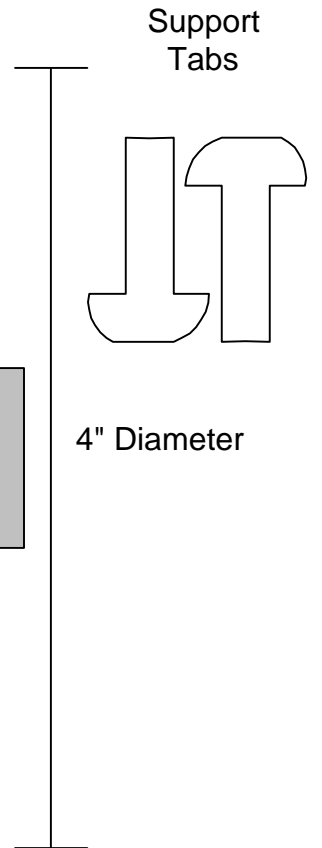
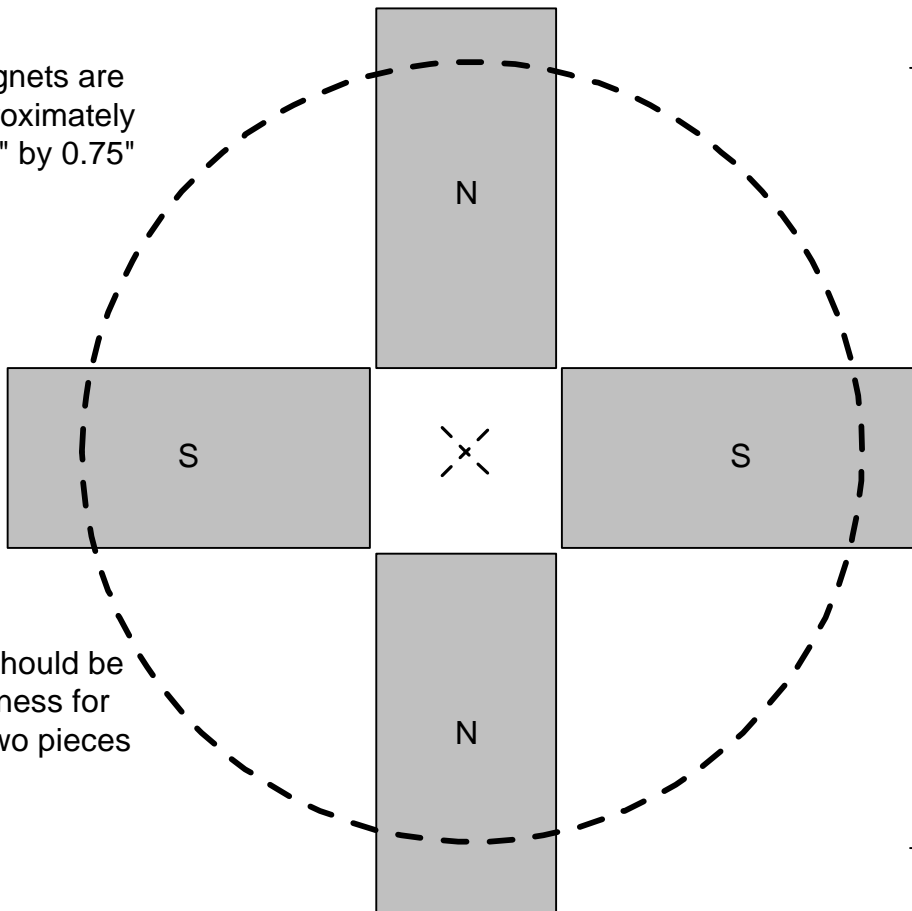

Cardboard should be double thickness for rotor (glue two pieces together)



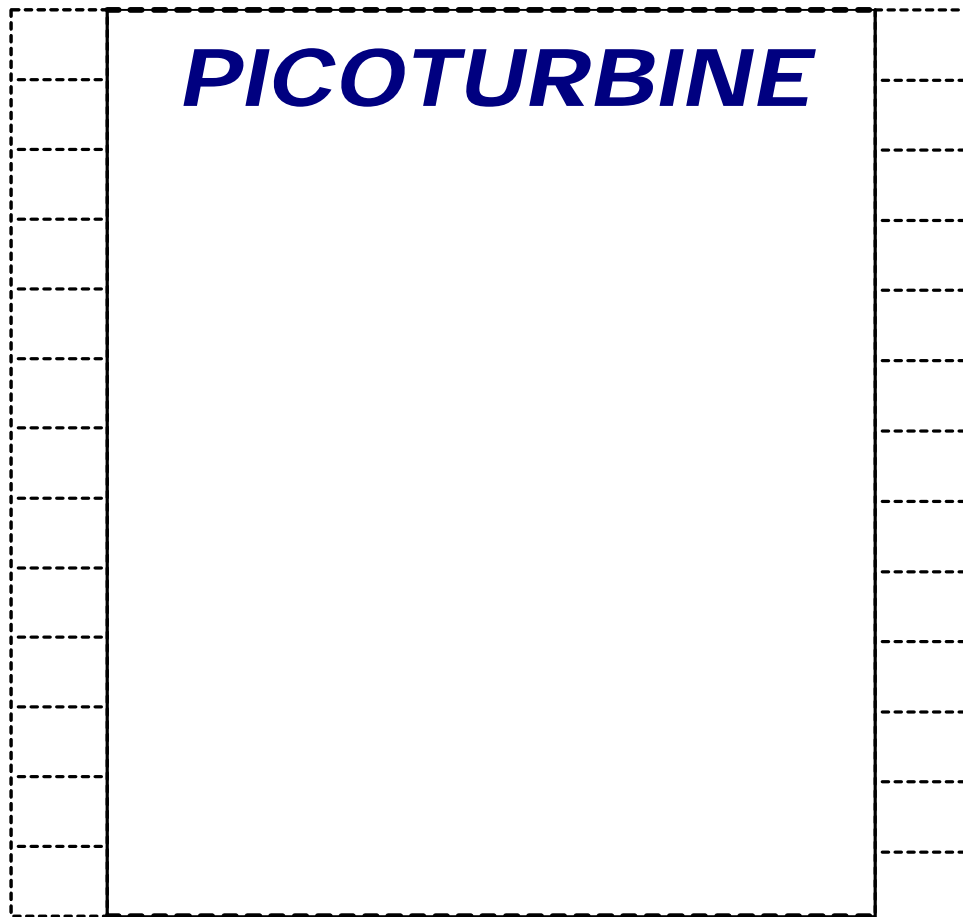
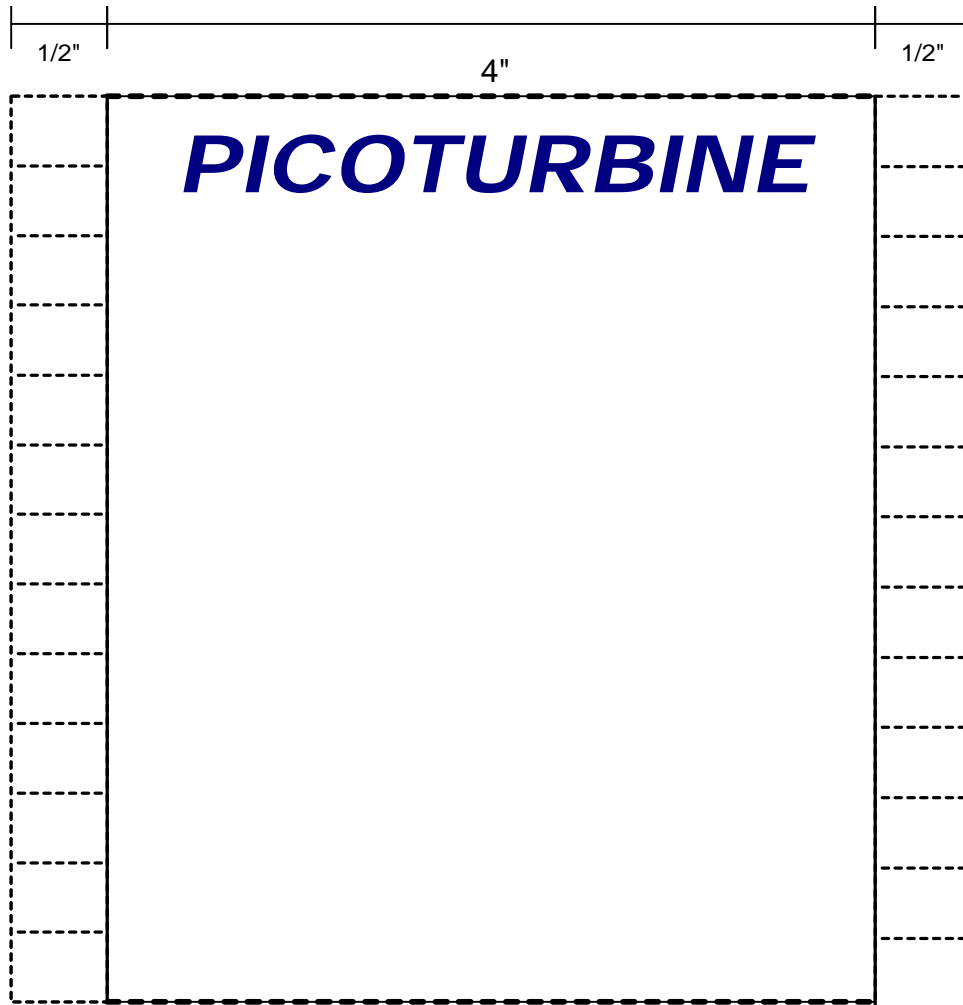

### Blade Coverings

Color/decorate if desired before cutting out.

Blade coverings ARE NOT glued to cardboard.

4.5" Cut on dotted lines  
Feather the ends of the paper to make gluing to the rounded blade supports easier.

